

Specifications and Installation: RNET-OCC-HV-P-CM 360° Passive Infrared Line Voltage Occupancy Sensor

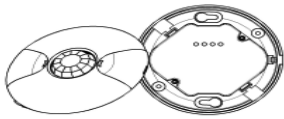

SPECIFICATIONS

Incandescent	800W-120VAC, 60Hz
Ballast	800VA-120VAC / 1600VA-277VAC, 60Hz
Resistive	10A, 120VAC, 60Hz
Motor	1/4 HP, 120VAC, 60Hz
Operating Temperature	32°F to 131°F (0°C to 55°C)
Adjustable Light Level	10FC—150FC
Adjustable Time Delay.....	15 sec.-30min
Sensitivity Adjustment	50% or 100% (DIP switch 1)
Coverage	Up to 1200 ft ²

DESCRIPTION

The RNET-OCC-HV-P-CM 360° passive infrared (PIR) occupancy sensors turn lighting systems on and off based on occupancy and ambient light levels. The light level feature keeps lights from turning on if the ambient light level is sufficient. The sensors can be configured to turn lighting on, and hold it on as long as the sensor detects occupancy. After no movement is detected for a specified time the lights are switched off.

COVERAGE PATTERN

The RNET-OCC-HV-P-CM provides a 360° coverage pattern, up to 1200 square feet. The coverage shown represents walking motion at a mounting height of 8 feet (See Figure 1). For building spaces with lower levels of activity or with obstacles and barriers, coverage size may decrease.

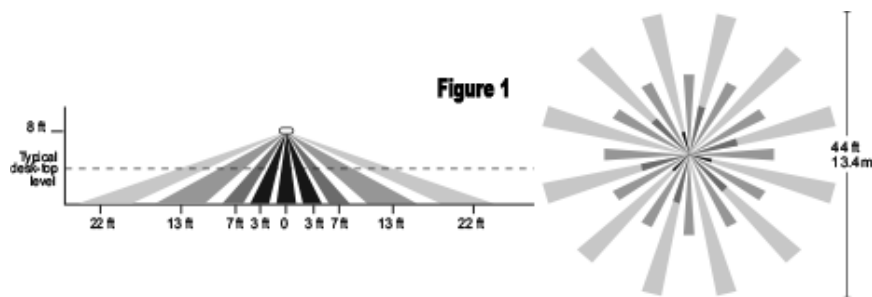

PLACEMENT GUIDELINES

Depending upon obstacles such as furniture or partitions, the area of coverage may be less or more than the sensing distances shown in the coverage pattern.

This must be considered when planning the number of sensors and their placement. It is also recommended to place the sensor 4 to 6 feet away from air supply ducts as rapid air currents or the differences in temperatures may cause false activations.

Mount the sensor to the ceiling. The RNET-OCC-HV-P-CM are designed for a ceiling height of about 8-10 feet. Mounting above or below this range will significantly affect the coverage patterns. Be aware that as you decrease the mounting height, you decrease the range and increase the sensitivity to smaller motions. Conversely when you increase the height, you increase the range and decrease the sensitivity to smaller motions. At heights of more than 12-14 feet, you may start to significantly reduce sensitivity. As a general rule, each occupant should be able to clearly view the sensor.

Often the best location to install a RNET-OCC-HV-P-CM in a closed office is off-center (see Figure 2). Avoid placing a sensor directly in line with an open door through which it has a clear view out, as the sensor may detect people walking by.

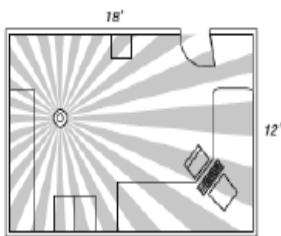

Figure 2

Open Office Area Coverage:

To get complete coverage in an open office area, install multiple sensors so that there is an overlap with each adjacent sensor's coverage area. See the Figure 3.

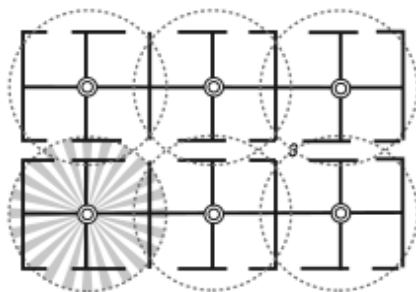

Figure 3

WIRING DIRECTIONS

WARNING: Turn off the power at the circuit breaker before installing. Refer to the wire diagram of the sensor (see figure 4), and connect the wires of ceiling sensors as followed by using the wire nuts provided.

1. Connect the Hot wire to the Black wire from the sensor.
2. Connect the Load wire to the Red wire from the sensor.
3. Connect the Neutral wire to the White wire from the sensor.
4. Connect the two Grey wires (22AWG) to the terminals of the momentary switch.

You can add a MANUAL SWITCH to the sensor by connecting the Grey wires.
(Step 4 is not necessary if you don't want to use the function of MANUAL ON/OFF)

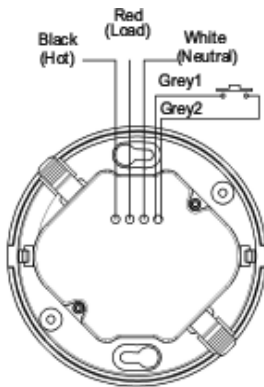

Figure 4

LIGHT LEVEL ADJUSTMENT

Turn the potentiometer on the sensor to the "-" if adequate ambient light. The output of sensor will be inhibited, and the load cannot be on, only when the ambient light is down to a certain level the sensor will automatically turn on. Therefore, potentiometers require customers to adjust in accordance with the location and the ambient light level.

Turn the potentiometer on the sensor to the "+", regardless of the ambient light level. The load will be on as long as there are signals from occupancy.

1. Avoid mounting the sensor close to lighting fixtures.
2. Adjust during daylight hours when ambient light in the area is at desired level. Open the Front Cover and adjust the Light level.

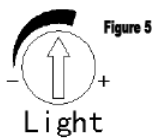

MOUNTING

Using an Octagonal Junction Box

1. Pull the high voltage wires into the J-Box through the conduit knockout.
2. Connect the high voltage wires to the appropriate terminals on the sensor.
3. Loosen the appliance mounting screws attached to the J-Box.
4. Align the sensor in the J-Box so that the mounting screws on the box match the key holes on the sensor's rear housing.
5. Push the sensor up into the J-Box and twist it so that the mounting screws are seated in the keyhole slots.
6. Tighten the two screws to secure the sensor to the J-Box.
7. Snap the front cover onto the sensor (see Figure 6)

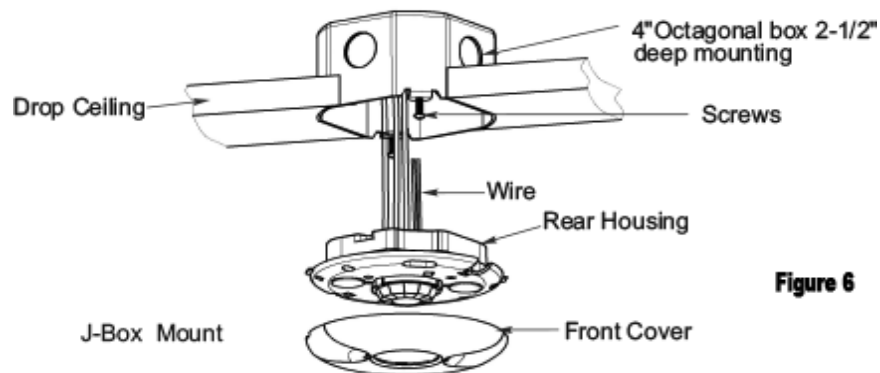

SENSOR ADJUSTMENT

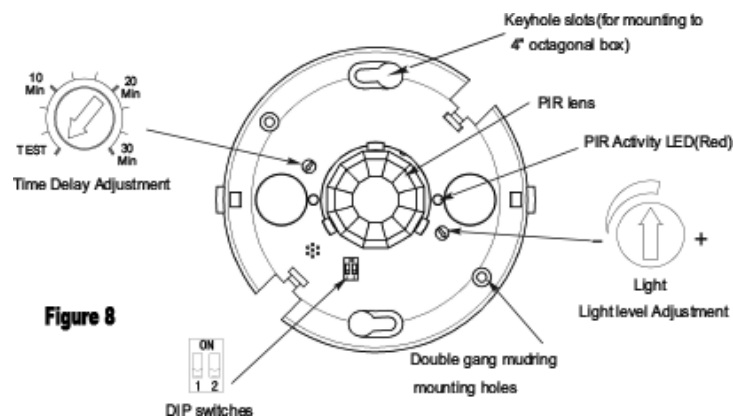

Note: There is a 40- second warm-up period when power is first applied. The sensors are factory preset to allow for quick installation in most applications. Verification of proper wiring or coverage, or customizing the sensor's settings can be done using the following procedures. To make adjustments, open the Front Cover with a small screwdriver.

Sensor Test:

Refer to the Figure 8 above.

1. Ensure the PIR Activity is enabled, red LED flashes, and PIR Sensitivity is set to 100% (DIP switch 1 OFF).
2. Ensure the Time Delay is set for Test Mode.
3. Ensure that the Light Level is at the maximum position. (See" LIGHT LEVEL ADJUSTMENT").
4. Remain still. The red LED should not flash. The lights should turn off after 15 seconds. (If not, see "TROUBLESHOOTING.")
5. Move about the coverage area. The lights should come on. When testing and adjustment is complete, reset DIP Switches, Time Delay and Light Level to the desired settings, and replace the cover on the sensor.

DIP SWITCH SETTING

The RNET-OCC-HV-P-CM has 2 DIP switches under the cover. They are used to set sensitivity, vacancy mode feature settings.

Sensitivity	1	Vacancy	2
50%	↑	Enabled	↑
100%	↓	Disabled	↓

↓ =OFF ↑ =ON ◀ =Factory Setting

Sensitivity setting: DIP Switch 1

1. 50%, sensor's coverage is smaller, just about half of the widest range.
2. 100%, the maximum range of sensor's coverage is 1200 square feet (see "COVERAGE PATTERN")

Vacancy Mode: DIP Switch 2

Manual ON function is achieved by using a momentary switch. The switch is connected to the two grey wires (22AWG). The operation of the sensor connected to manual switch depends on the DIP switch 2 setting.

Enabled State: Turn the lights on manually .When motion is no longer detected in a selected time, lights will change to OFF. When the selected time expires, the sensor will change to ON automatically if motion is detected again in 30 seconds.

Disabled State: In this mode ,when motion is detected in the area ,lights turn on automatically; When motion is no longer detected, light remain ON for a selected time, when the selected time expires ,lights turn off automatically.

A manual switch provides the following additional functionality:

- a. The load can be turned ON by manual switch activation and it stays on as long as occupancy is detected. The sensor time delay operates as programmed. When the load turns OFF due to lack of occupancy detection, the load can be turned ON again by occupancy detection or switch activation.
 - b. Turn the lights OFF manually when it is ON.
1. When the load is turned OFF manually, as long as the sensor continues to detect occupancy the load stays OFF. Selected time after the last occupancy detection, the lights stay off and the sensor reverts to the automatic-on mode.
 2. When the load is turned OFF manually, pressing the switch again turns the load ON and the sensor reverts to the automatic-on mode.
 3. Once the sensor returns to automatic-on mode, either the switch or occupancy detection can turn the load ON.

TROUBLESHOOTING

WARNING: Turn off the power at the circuit breaker before installing.

Lights do not turn on with occupancy, and the following condition exists:

PIR Activity LED does not flash:

NOTE: When power is initially applied to the sensor, there is a warm-up period of up to 40 seconds before the LED is active.

1. Check that the circuit breaker has been turned back on.
2. Make sure that the PIR Sensitivity is set for Max (DIP switch 1 OFF).
3. Make sure the wire is connected right.

PIR Activity LED flashes:

1. If the sensor's Light Level has been turned to "-", the lights connected to the Light Level Output might be held off because of the level of ambient light in the controlled area. To test whether the Light Level adjustment is the problem, cover the PIR lens and PIR Activity LED (see diagram) with your hand to see if the lights turn on. If the lights turn on, the Light Level setting was keeping the lights off (see, "Sensor Adjustment" for readjustment).
2. Make sure the wire is connected right.

Lights do not turn off automatically:

1. The sensor may be experiencing activations from outside the controlled or from some type of interference (see "Unwanted Sensor Activations" below).
2. Make sure the wire is connected right.

Unwanted Sensor Activations (LED flashes):

Possible causes:

1. The PIR sensitivity may be set too high.
2. Sensor located too close to HVAC or VAV vents with heavy air flow.

Possible solutions:

1. Set DIP switch 1 to ON and see if the excess activations stop.
2. Relocate the sensor.

WARRANTY INFORMATION

Our company warrants this product to be free of defects in materials and workmanship for a period of two (2) years. There are no obligations or liabilities on the part of our company for consequential damages arising out of, or in connection with, the use or performance of this product or other indirect damages with respect to loss of property, revenue or profit, or cost of removal, installation or reinstallation.